

QPA-2500-2570-34-33

2.5~2.57GHz, 34dB, 33dBm

Features:

- * Small Size
- * Low Power Consumption

Applications:

- * Wireless
- * Transmitter
- * Laboratory Test

Electrical

Frequency:	2.5~2.57GHz
Power Gain:	34dB min.
Gain Flatness:	±1dB typ.
Output Power (P1dB):	33dBm min.
Spurious:	-60dBc typ. (DC~10GHz@Pout=33dBm)
2 th Harmonic:	-45dBc typ.
Input VSWR:	1.45 typ.
Output VSWR:	2.0 typ.
Voltage:	12V DC
Input Power:	-2dBm typ.

Mechanical

Size ^{*1} :	98*58*20mm 3.858*2.283*0.787in
RF Connectors:	SMA female
Power Supply Interface:	Feed through
Mounting:	4-Φ3.6mm through-hole
Cooling:	Forced Air

[1] Exclude connectors.

Environmental

Operating Temperature:	-10~+50°C
------------------------	-----------

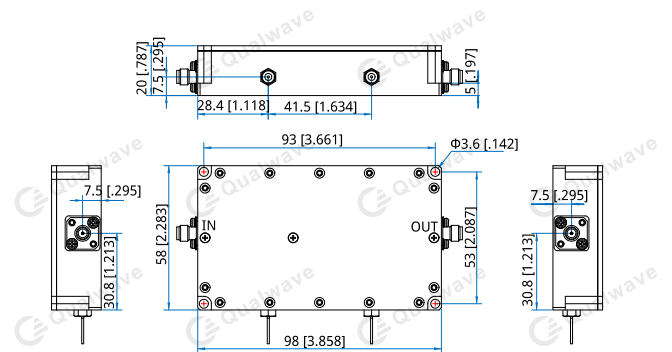
Outline Drawings

Unit: mm [in]

Tolerance: ±0.2mm [±0.008in]

How To Order

QPA-2500-2570-34-33

Customization is available upon request.