

QPS4-200-35000-R

SP4T, 0.2~35GHz, Reflective

Features:
 * Low Insertion Loss
 * High Isolation

Applications:
 * Wireless
 * Transmitter
 * Laboratory Test
 * Radar

Electrical

Frequency:	0.2~35GHz
Insertion Loss:	5dB max.
Isolation:	60dB min.
VSWR:	2.2 max.
Input Power:	23dBm max.
Voltage/Current:	+5V@200mA max. -5V@50mA max.
Control:	TTL High - 1 TTL Low/NC - 0
Impedance:	50Ω

Mechanical

Size ^{*1} :	50.8*20*10.2mm 2*0.787*0.402in
Switching Time:	150ns max.
RF Connectors:	2.92mm Female
Power Supply Connectors:	Feed Through/Terminal Post
Housing Material:	Nickel plated aluminum
Mounting:	4-Φ2.8mm through-hole

[1] Exclude connectors.

Environmental

Operating Temperature:	-40~+85°C
Non-operating Temperature:	-55~+125°C

Outline Drawings

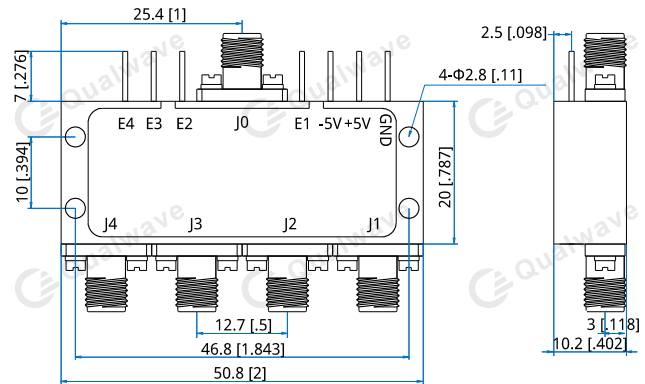

Unit: mm [in]
 Tolerance: ±0.2mm [±0.008in]

Control True Table

E4	E3	E2	E1	Connection
1	1	1	0	J0 - J1 On
1	1	0	1	J0 - J2 On
1	0	1	1	J0 - J3 On
0	1	1	1	J0 - J4 On

How To Order

QPS4-200-35000-R

Customization is available upon request.